



TTSIM-1A

TraceTek® Sensor Interface Module with Relay



Installation/Operation Instructions

General Information

Please read these instructions and keep them in a safe place. These instructions must be followed carefully to ensure proper operation.

The TTSIM-1A has been designed for use with TraceTek sensing cables, point sensors and normally open, dry contact devices (float switch, pressure or vacuum switch, optical probe with adapter, limit switch, etc.). Up to 150 m (500 ft) of sensor cable can be monitored by the TTSIM-1A. Contact factory for information regarding longer monitoring distance.

The TTSIM-1A is designed for installation in ordinary (non-hazardous) areas. The TTSIM-1A has five small LED's to indicate power, status and communications activity, as well as a relay with SPDT contacts. The TTSIM-1A can be used as a stand-alone leak detection alarm, or connected to a host system (TraceTek TTDM-128, computer, or control automation system) via simple, shielded twisted pair RS-485 serial communication wiring.

Installation Items (not supplied)

- 35 mm DIN rail mounting strip (for wall mounts or interior of large control cabinets) and attachment hardware.
- TT-RS485 power and telemetry cable.
- Optional TTSIM-ENC-4X-OUTDOORS environmental enclosure for outdoor or corrosive environments, or TTSIM-ENC-4X-INDOORS enclosure with clear cover for indoor, non-corrosive environments.

Tools Required

- Small flat blade screwdriver
- Small needle nose pliers
- Tools to mount DIN rail or enclosure

Storage

Keep the TTSIM-1A modules in a dry place prior to installation. Avoid damage to components.

Product Information

TTSIM-1A	22 to 26 Vac, 50/60 Hz, 3 W
TTSIM-1A-120	92 to 132 Vac, 50/60 Hz, 3 W
TTSIM-1A-230	216 to 253 Vac, 50/60 Hz, 3 W
Relay contacts	Form C (SPDT), 250 Vac/30 Vdc at 2 Amps maximum
Installation categories	Overvoltage Category II Pollution Degree 2
Storage temperature	-18°C to 60°C (0°F to 140°F)
Operating temperature	0°C to 50°C (32°F to 122°F)
Enclosure	NEMA 1; IP00 (NEMA 4X / IP 56 with optional enclosure)

Approvals



Additional Items

An agency-approved zener barrier must be used where sensing cable connected to the TTSIM-1A will be located in Class1 Div 1 (Zone 0 or 1 in Europe) Hazardous Locations.

Installing the TTSIM-1A

Note: To avoid damage to the TTSIM-1A, store the unit in its packaging until ready to install.

Selecting the mounting position

Choose a location where the module will be protected from the elements, temperature extremes or heavy vibration. The TTSIM-1A is designed to be snapped onto standard 35 mm DIN rail. Existing electrical or instrumentation cabinets with spare rail space make good mounting locations. It is also possible to install a small section of DIN rail directly on a wall or cabinet surface and mount the TTSIM-1A in any location as long as it does not create a tripping hazard or expose the TTSIM-1A to impact damage. The TTSIM-1A should be mounted within 1200 m (4000 ft) wire run from the controlling TTDM-128 or control system host. Contact the factory for methods to increase the wire run distance beyond 1200 m.

Important: The TTSIM-1A is an electronic unit. Take the following precautions to avoid damage to electronic components:

- Handle with care and avoid mechanical shock and impact.
- Keep dry.
- Avoid exposure to static electricity by touching a nearby piece of grounded equipment or water pipe prior to handling the TTSIM-1A.
- Avoid contact with metal filings, grease, pipe dope and other contaminants.

Mounting the TTSIM-1A module (without NEMA 4X Enclosure--Figure 1)

- Secure a sufficient length of DIN rail to the desired mounting surface, or locate an existing DIN rail with sufficient space to install the TTSIM-1A.
- Remove the TTSIM-1A from its packaging and snap onto the DIN rail with the release tab towards the bottom.

Mounting the TTSIM-1A module in the optional NEMA 4X Enclosure--Figure 2

- Plan conduit alignment and drill holes as necessary.
- A typical outdoor or harsh environment installation will require three holes in the TTSIM-ENC: one for inbound power and telemetry, one for outbound power and telemetry and one for the sensor cable leader.
- Secure the TTSIM-ENC to any convenient vertical surface using the four corner mounting holes and hardware suitable for the selected surface.
- Rough-in conduit as required and pull the cables for power and telemetry. Leave approximately 20 cm (8 in) for connection to TTSIM terminals. Pull in the sensor circuit leader cable.
- In order to provide maximum electrostatic discharge protection, and to be CE compliant, the DIN rail must be grounded.

Note: Rough-in and final connections do not have to be completed at the same time, however make sure to replace the cover and tighten the cover screws if the enclosure will be left in a partially installed condition overnight or longer.

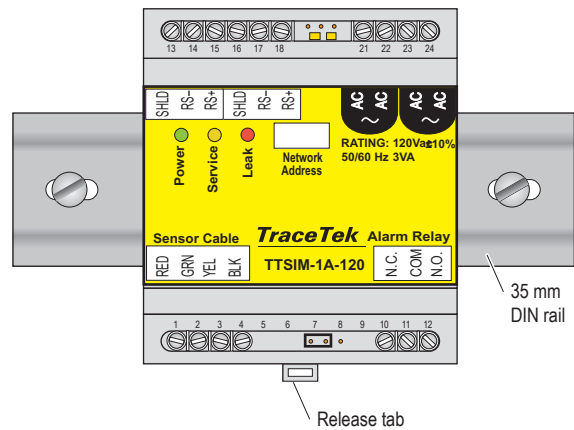

Figure 1. DIN rail mount

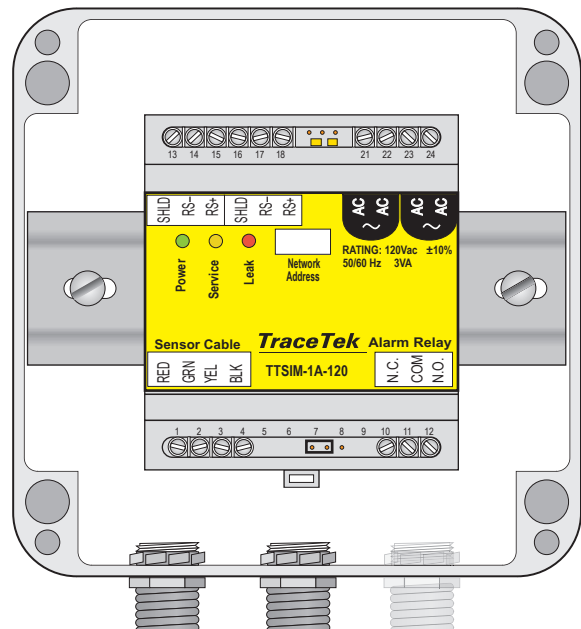

Figure 2. NEMA 4X enclosure

Power Supply Options

The TTSIM-1A has several power supply options available. Depending on the version being installed and local regulations, the wiring requirements may vary. In all cases, be sure that each TTSIM-1A receives supply voltage from one and only one source.

Connections for Power and Telemetry

TTSIM-1A communicates all alarm and status messages via RS-485 shielded twisted pair telemetry. Two of the four conductors in the power/telemetry cable are used for telemetry and the other two wires may be used to provide the supply voltage. Alternatively, separate wiring may be used for the supply voltage, as shown in Figure 3.

For all TTSIM-1A modules except the last one, there will be an incoming cable (from the TTDM-128 or other host system) and an outgoing cable (to the next TTSIM-1A).

- Strip a sufficient amount of the jacket insulation and shielding to expose about 2.5 cm (1 in) of the four wires.
- Strip the primary wires to expose approximately 6 mm (1/4 in) of conductor and make the following connections: (see Figure 3)

Terminal	Color	Item	
13	—	Shield Drain Wire	
14	Black	RS-485 (-)	[Shielded twisted pair from TTDM-128, Host, or previous TTSIM]
15	Red	RS-485 (+)	
16	—	Shield Drain Wire	
17	Black	RS-485 (-)	[Shielded twisted pair to next TTSIM]
18	Red	RS-485 (+)	
21	Green	AC Supply	From source or previous TTSIM*
22	White	AC Supply	
23	[Green]	AC Supply	[To next TTSIM]
24	[White]	AC Supply	

* Power supply voltage must be within range specified on TTSIM-1A label.

Items in square brackets [] are optional. When using TraceTek TT-RS485 power and telemetry cable for power supply distribution, follow the color codes indicated in brackets.

Connections for Alarm Relay

The software programmable TTSIM-1A relay contacts may be used for local or remote annunciation, to control a valve or other device, or for connection to a control automation system contact input. The relay can be programmed to alarm on leak only or on either leak or sensor fault. The relay can also be programmed to be ON (coil energized) or OFF (coil de-energized) to signal an alarm (see table below). The relay can be programmed using either a TTDM-128 or a PC running TT-SUPERVISOR software.

Programmed Alarm State	Alarm Condition	Status at Terminals	
		10-11	11-12
On (default)	No alarms	closed	open
	Alarm	open	closed
	Loss of power	closed	open
Off	No alarms	open	closed
	Alarm	closed	open
	Loss of power	closed	open

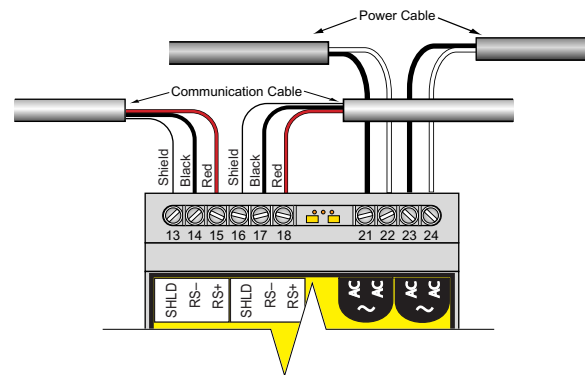

Figure 3. Power and Telemetry Connections

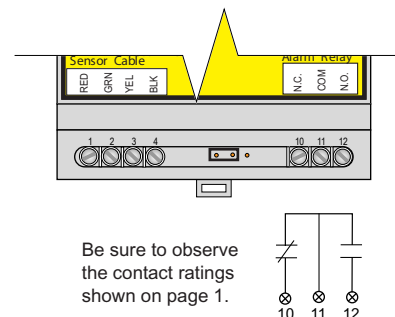

Figure 4. Alarm Relay Connections (shown in power off condition)

Place the End of Line Jumper in the correct position

If the TTSIM-1A will be connected to a host for communication, it is necessary to set the End of Line Jumper in the correct position as follows:

- On the last TTSIM in the circuit, place the jumper as shown in Figure 5a.
- On all other TTSIM's in the circuit, place the jumper as shown in Figure 5b.

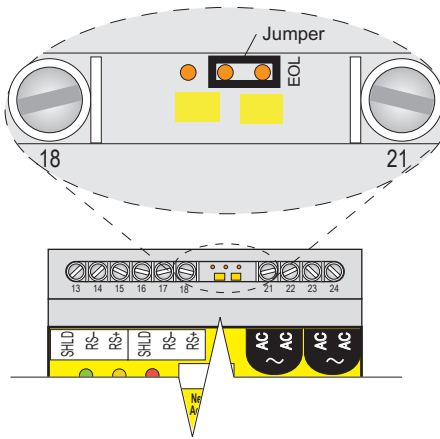

Figure 5a. End of Line Jumper for last TTSIM

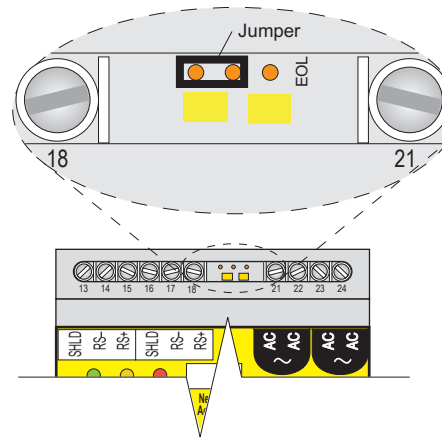

Figure 5b. End of Line Jumper for all other TTSIM's

Leader Cable Connections for Sensor

The TTSIM-1A can be used with any of the TraceTek family of sensors including: TT1000, TT3000, TT5000 and TT5001 cables, as well as float switches and point probes. Connect the TraceTek leader cable to the TTSIM as shown in Figure 6.

Terminal	Color	Item
1	Red	Red / Green Sensor Cable Loop
2	Green	
3	Yellow	Yellow / Black Sensor Cable Loop
4	Black	

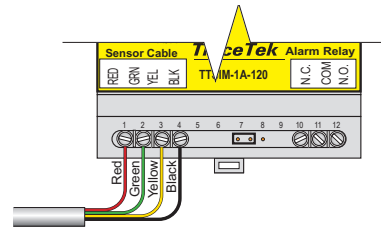

Figure 6. Sensing Cable Connections

Operating Instructions

Network Address Assignment

If the TTSIM-1A will be used in a TraceTek network, each module in a TraceTek network must have a unique address in the range 001 to 127. All TTSIM-1A units are shipped from the factory with their network address pre-set to a value above the range of valid addresses, in order to prevent communication conflicts during system startup and configuration. Each TTSIM must therefore be configured to a unique address before it can communicate with the TTDM-128 or other host.

To set the TTSIM-1A network addresses, repeat the following procedure for each TTSIM-1A. Perform the complete procedure one module at a time:

- Place the TTSIM-1A configuration jumper in the CFG position, as shown in Figure 7a.
- Using the TTDM-128 or host system, assign the new TTSIM-1A address (refer to the TTDM-128 User Manual or the TraceTek System Integration Manual for instructions).
- Place the configuration jumper in the normal operating position, as shown in Figure 7b, or remove it completely (the jumper is not required in normal operation).

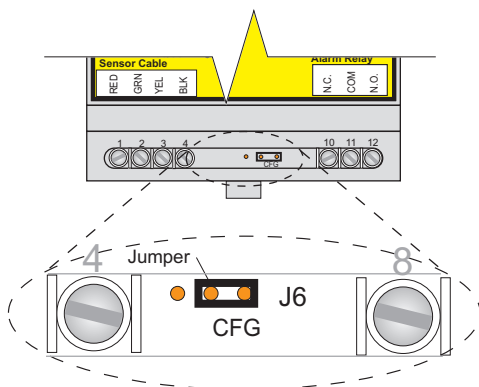

Figure 7a. Configuration Jumper in Configuration Position

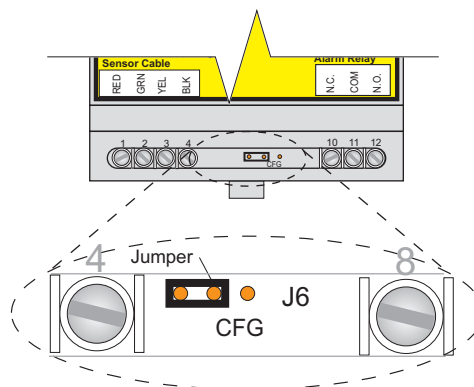

Figure 7b. Configuration Jumper set for Normal Operation

Maintenance and Troubleshooting

No user maintenance is required! There are no user adjustments or calibrations that can be performed in the field.

Each TTSIM-1A is tested and calibrated at the factory. An operating TTSIM-1A runs a continuous self check routine and reports any discrepancies to the TTDM-128 or host computer. If the TTSIM-1A or the network wiring fails in such a way that the TTSIM-1A cannot communicate with the host, then the host reports the failure as a communications failure.

Status Indicators

There are 5 LED's on the TTSIM-1A circuit board to indicate: power, communications (inbound and outbound), sensor status (leak detected and trouble). See Figure 9.

The green Power LED will be ON and will blink once every 5 seconds when the TTSIM-1A is powered and functioning correctly. Table 1 lists various sensor status conditions and possible corrective actions. Table 2 lists communication status conditions (applicable when the TTSIM-1A is used in a network system).

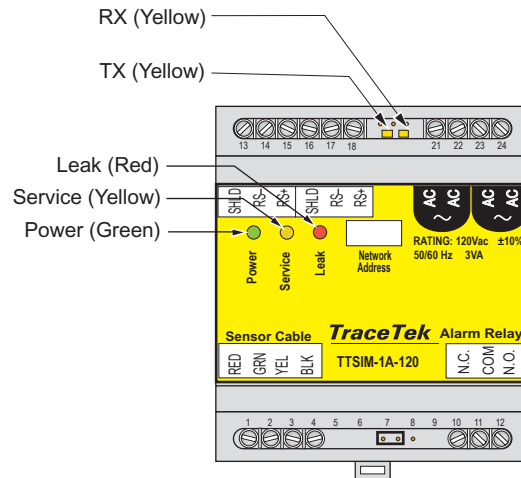

Figure 9. TTSIM-1A LED locations

Table 1. TTSIM-1A LED operational status indications

LEAK	SERVICE	INDICATION
FLASH		Leak detected. Check sensor for leak or spill.
ON		Leak alarm has been reset by operator but the leak condition still exists
	FLASH	The sensor needs servicing. Check sensor and leadwires/jumpers for continuity or contamination.

Table 2. TTSIM-1A communication status indications (only active if connected to a network)

TX	RX	INDICATION
FLASH	FLASH	Unit is communicating normally with TTDM-128 or host.
OFF	FLASH	Unit is receiving communication from TTDM-128 or host, but is not responding.
OFF	ON	RS-485 communication wires are reversed
OFF	OFF	Unit is not communicating with TTDM-128 or host.

Tyco Thermal Controls
 Worldwide Headquarters
 300 Constitution Drive
 Menlo Park, CA 94025-1164
 USA
 Tel: (650) 216-1526
 Fax: (650) 474-7513
 E-mail: info@tracetek.com
www.tracetek.com

Important: All information, including illustrations, is believed to be reliable. Users, however, should independently evaluate the suitability of each product for their particular application. Tyco Thermal Controls makes no warranty as to the accuracy or completeness of the information, and disclaims any liability regarding its use. Tyco Thermal Controls' only obligations are those in the Tyco Thermal Controls Standard Terms and Conditions of Sale for this product, and in no case will Tyco Thermal Controls or its distributors be liable for any incidental, indirect, or consequential damages arising from the sale, resale, use or misuse of the product. Specifications are subject to change without notice. In addition, Tyco Thermal Controls reserves the right to make changes – without notification to Buyer – to processing or materials that do not affect compliance with any applicable specification.

Tyco, TraceTek and the TraceTek logo are trademarks of Tyco Thermal Controls LLC or its affiliates.