



# TTDM TraceTek Leak Detection and Location Module

## Product Information

<b>TTDM-1</b>	115 Vac +15%, -20%; 50/60 Hz
<b>TTDM-2</b>	230 Vac ±10%; 50/60 Hz
<b>TTDM-24</b>	24 Vac +5%, -35% 24 Vdc ±20%
<b>Power consumption</b>	6 VA (5 W) for TTDM-1 and TTDM-2 12 VA (10 W) for TTDM-24
<b>Installation categories</b> (per IEC 664)	Overtoltage Category II Pollution Degree 2
<b>Relays</b>	Number: Three (Service, Leak, Fault) Type: DPDT Rating: 5 A at 250 Vac/24 Vdc
<b>Temperature</b>	Storage: 0°F to 140°F (-18°C to 60°C) Operating: 32°F to 122°F (0°C to 50°C)
<b>Enclosure</b>	NEMA 12; IP 54

## Approvals and Certifications

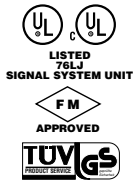

The TTDM is approved for use in ordinary areas. The module must be located in an Ordinary Area, but may monitor intrinsically safe TraceTek sensing cables located in Hazardous Locations:

- TraceTek sensing cable in Class I, Division 2, Groups A, B, C, D Hazardous Locations
- If protected by agency-approved zener barrier TraceTek sensing cable in Class I, Division 1, Groups A, B, C, D Hazardous Locations (Zone 0 or Zone 1 in Europe). Contact Raychem to select proper zener barrier.

UL based their evaluation of the unit on UL Standard 864. Since UL 864 is intended for the evaluation of fire alarm control units, only certain requirements particular to the subject product's use and construction were applicable. The system was evaluated for its inherent risk of fire and electric shock only. Its intended purpose is to detect and locate liquid leaks, not to serve as the primary means to prevent a critical process from becoming a risk of electric shock or creating a fire or other hazard.



The module is compliant with IEC-801-2, 3, 4, 5. It meets the requirements of FCC, Part 15, Class B, and EN 55011-2 Class B.

## Additional items

An agency-approved zener barrier must be used for cases where sensing cable connected to the TTDM will be located in a Class I, Division 1 (or Zone 0 or Zone 1 in Europe) Hazardous Location. A zener barrier also may be selected to provide lightning protection.

## General Information

Please read these instructions carefully and keep them in a safe place (preferably close to the module) for future reference. These instructions must be followed carefully to ensure proper operation.

The TTDM Alarm and Locating Module has been designed specifically for use with TraceTek sensing cables (TT1000, TT3000, and TT5000 sensing cables and TT100, TT300, and TT500 long-line sensing cables). The TTDM can monitor up to 5000 ft (1500 m) of sensing cable, or 100 zones.

The TTDM is designed for use in ordinary areas with temperatures of 32°F to 122°F (0°C to 50°C). The TTDM should be provided with branch circuit protection (no more than 20 A rating). A disconnect device should be included as part of the installation and marked as such; when a circuit breaker is used as a disconnect device, it should meet the relevant requirements of IEC 947-1 and IEC 947-2. Follow all national and local codes applicable to the installation.

## Installation items (not supplied)

- Wall fasteners for surface mounting (four screws)
- Rubber or elastomeric washers to seal at mounting points

## Tools required

- Drill or hole punch for electrical conduit entries
- Phillips (cross-head) screwdriver
- Small flat-head screwdriver

## Storage

Keep the module in a dry place prior to installation to avoid possible damage to internal components.

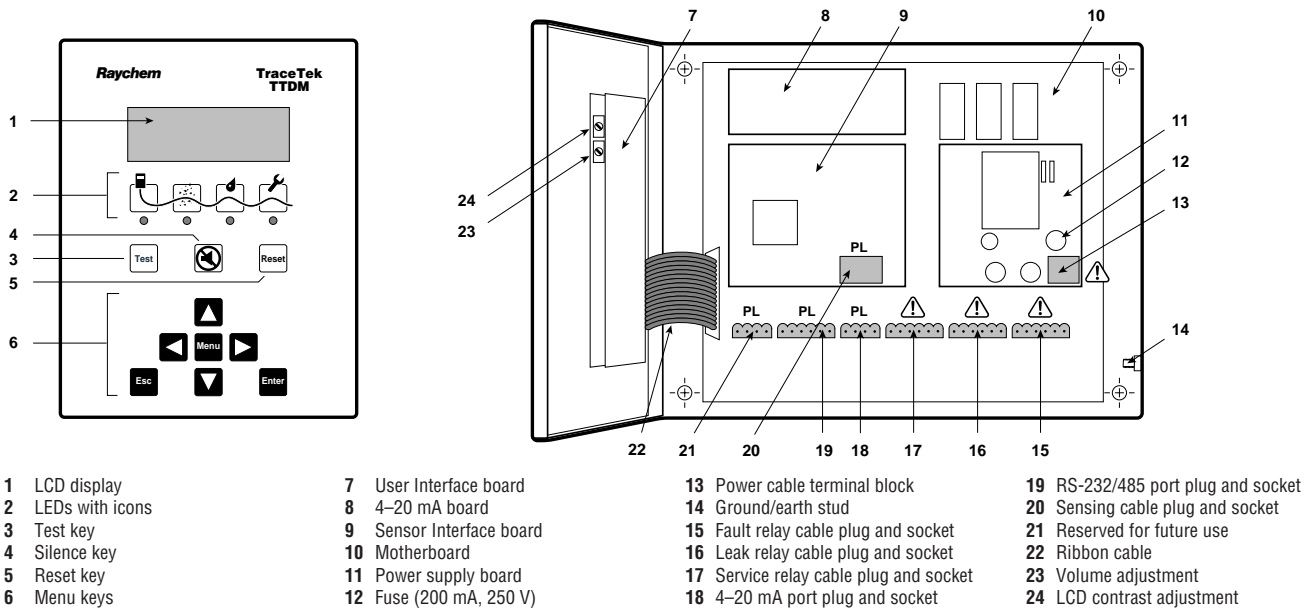

PL indicates power limited circuits

**WARNING:** Shock hazard. Shut off power before opening enclosure door.

## Installing the TTDM

**Note:** To avoid damage to the unit, store the TTDM module in its cardboard box until construction is complete.

### Select the mounting position.

Choose a location indoors where the module will be protected from the elements and temperature extremes.

**⚠ WARNING:** Ignition hazard. Do not mount the TTDM unit in a hazardous location. Sensing cable connected to the TTDM may (subject to approvals restrictions) be located in hazardous locations, but the module itself must be in an ordinary area.

### Prepare the module for mounting.

**Important:** The TTDM is an electronic unit. During installation, take the following precautions to avoid damage to its electronic components:

- Handle with care, avoid mechanical damage.
  - Keep the electronics dry.
  - If handling circuit boards, hold them by their edges to avoid physical contact with electronic components.
  - Avoid exposure to static electricity.
  - Avoid contamination with metal filings, liquids, or other foreign matter.
  - Remove the module from its carton. Do not remove the protective film from the membrane on the front of the unit.
  - Open the enclosure door using a flat-blade screwdriver or a coin.
  - Carefully disconnect the ribbon cable from the motherboard.
  - To allow access to the fourth motherboard mounting screw, remove the 4–20 mA board by pulling up from the motherboard (see Figure 1), and put it out of harm's way.
  - Unscrew the four Phillips (cross-head) screws holding the motherboard to the enclosure (see Figure 1). Remove the motherboard, and put it out of harm's way.
  - Taking care to protect the User Interface board on the enclosure door, drill/punch entries as required (see Figure 2).
- Note:** The TraceTek sensing circuit is power limited, so the TraceTek leader or jumper cable and the power supply cable must not run in the same conduit.
- Fit conduit bushings/adapters.
  - Remove all traces of metal filings and dust from inside the module enclosure.

### Mount the module.

The module mounts with four screws with mounting centers as noted in Figure 3. If plastic plugs are in the mounting holes, remove them. To seal around the mounting screw (necessary to maintain the NEMA 12 rating), use a rubber or elastomeric washer.

### Reassemble the module.

Note: before replacing the motherboard, ensure that the interior of the enclosure is clean.

- Replace the motherboard and secure it in place with the Phillips (cross-head) screws.
- Replace the 4–20 mA board, taking care to align the connectors properly before applying pressure to seat the board. Markings on board should be right side up.
- Reconnect the ribbon cable (taking care not to bend any pins in the connection).
- To seal the bottom of the enclosure, put plastic plug (supplied in plastic bag with other small parts) into hole in bottom of enclosure.
- Close and latch the door of the enclosure.

Figure 1

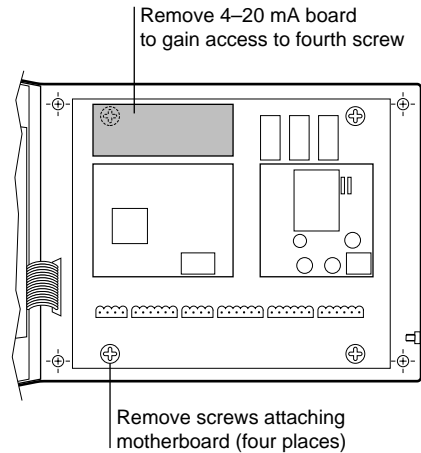

Figure 2

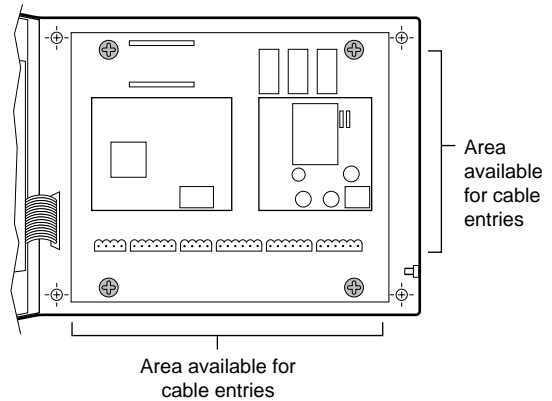
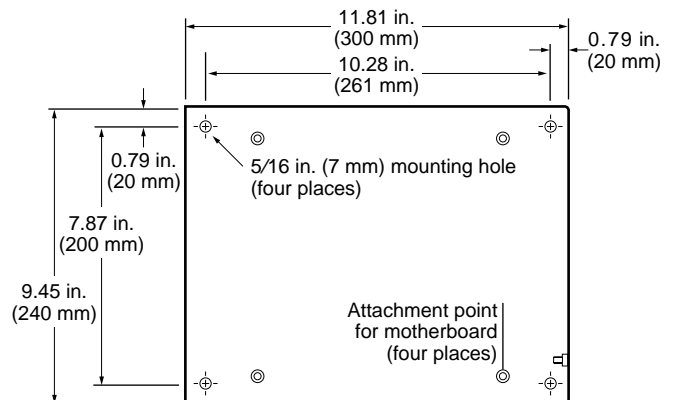

Figure 3



## Connecting the Power Cable and Relays

### Connect the power wiring.

- Open door of TTDM enclosure.
- Pass the power cable through the adapter/bushing.
- Connect the ground/earth wire to the ground/earth stud.

The ground/earth stud is marked with this symbol:

**Note:** Proper grounding/earthing is important to avoid the possibility of electromagnetic interference.

**Note:** Ground/earth wire must be longer than the other two conductors for strain relief.

- Connect the power supply wires to the two-pin terminal block on the power supply board. Use L2 for neutral, if present.

**Note:** The terminals can accept wires 10 AWG (4.7 sq. mm) or smaller. We recommend 12 AWG (3.0 sq. mm) wires, with branch circuit protection sized accordingly. Cable should have a temperature rating of 65°C.

Do not exceed maximum voltage rating.

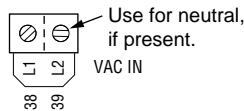

### Connect the alarm relays.

The TTDM has three relays, for service, leak, and fault. Each relay provides two Form-C relay contacts, and normally open and normally closed contacts are both provided. The relays are **de-energized to indicate an alarm** condition. The illustration below shows the relay status when in the alarm (de-energized) state.

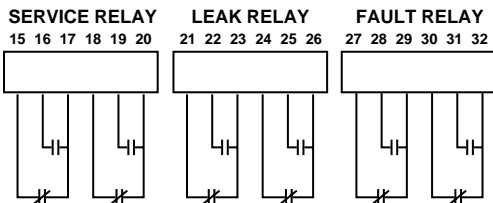

The illustrations that follow show how relays can be jumpered together to allow remote monitoring of the TTDM status with only a single pair of wires. The TTDM **de-energizes** its relays to signal an alarm condition. Therefore, loss of power, as well as any other type of alarm, would trip the remote alarm.

#### Alarm on open circuit

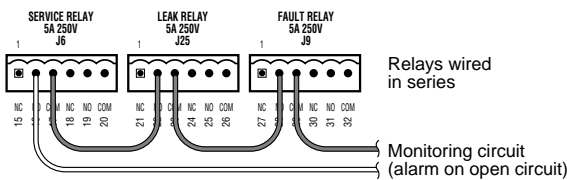

#### Alarm on closed circuit

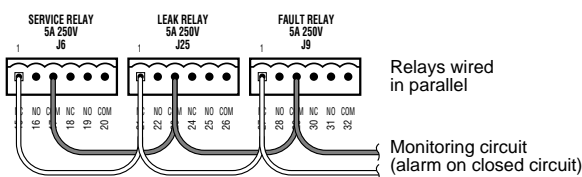

**Note:** The relay plugs can accept wires 10 AWG (4.7 sq. mm) or smaller. We recommend 18 AWG (1.0 sq. mm) wires. Cable should have a temperature rating of 65°C.

**Note:** Maximum load for relays is 5 A.

## Testing the Module

### Test after supplying power.

- Close and latch the enclosure door.
- Supply power to the unit. When power is supplied, the green LED illuminates, and the unit goes through a series of self-tests. After the start-up sequence is complete, the module should report a fault alarm (this is normal; there is no sensing cable attached). Press the red Silence key to silence the audible alarm. Verify that the display appears as shown below (but with different time and date):

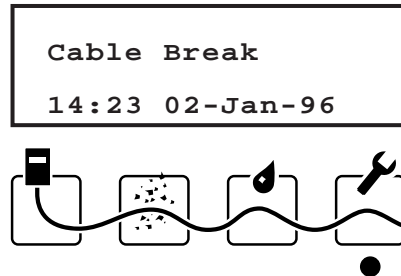

If anything other than the above occurs, check all connections. If unit still does not appear to operate properly, contact a Raychem TraceTek representative for assistance.

- Press the Test button. The module conducts a number of self-tests.
- If the tests are successfully completed, record this on the installation record.
- Interrupt the power supply to the unit.

### Test with TTDM test plug.

- To conduct a more complete test, use the TraceTek TTDM-CTP test plug (packed in a plastic bag in the TTDM packaging). Insert the plug into the sensing cable socket; align it with the four color coded pins.
- Close and latch the enclosure door.
- Supply power to the unit. When power is supplied, the unit will again go through a series of self-tests. If the test plug is in the sensing cable socket, after the module completes the start-up sequence it should sound and display a leak alarm. Press the Silence key to silence the audible alarm. The red Leak LED and green Monitoring LED should both be illuminated, and the screen display should appear as shown below (depending on the setting):

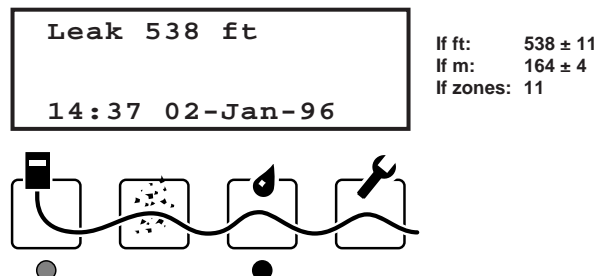

- If anything other than the above occurs, check all connections. If unit still does not appear to operate properly, contact a Raychem TraceTek representative for assistance.
- If the test is successfully completed, record this on the installation record.
- Interrupt the power supply to the unit.
- Remove the TTDM test plug and store it in a secure place for future use.
- If not immediately connecting the sensing cable, close and latch the enclosure.

## Connecting the Sensing Cable

### Prepare sensing cable.

Ensure that the sensing cable has been installed and tested in accordance with the instructions provided with the cable.

### Make connections.

- Confirm that power to the unit has been shut off.
- Open the enclosure door.
- Feed the end of the TraceTek Modular Leader Cable (or Jumper Cable) through the adapter/bushing.
- Connect the four color-coded wires to the Sensor Interface plug.

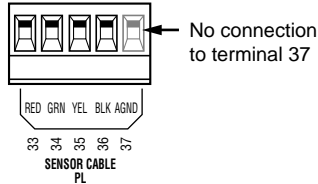

**Important:** Observe the color coding. If wires are not connected to the proper terminals, the leak detection system cannot operate properly.

- Insert the sensing cable (SI) plug into the SI socket (item 20 on the product illustration on the first page).

### Install zener barrier, if applicable.

When sensing cable will be located in Class I, Division 1 locations, approval agencies require that the sensing cable be protected with a zener barrier between the sensing cable and the TTDM module. A zener barrier may also be used to provide lightning protection for the module when the sensing cable may be exposed to electrical discharges. Contact Raychem to select the proper zener barrier.

When installing a zener barrier, wire it in accordance with the instructions provided with the kit.

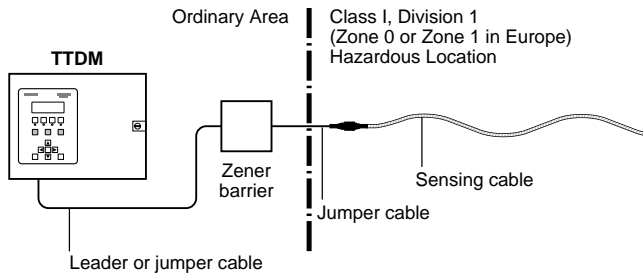

## Connecting the Interfaces

If connecting the 4–20 mA port or the RS-232/RS-485 serial port, refer to the *TraceTek TTDM Operation and Maintenance Manual* for details.

## Start-Up and System Testing

### Power up the system.

After connections are complete, supply power to the unit. The unit will go through a series of self-tests, and then display the system status. If the sensing circuit is complete and free of leaks or other problems, the green Monitoring LED **only** will illuminate, and the LCD display will appear as follows:

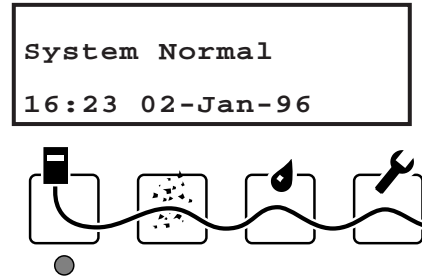

If this is not the case, you can find additional information in the *TTDM Operation and Maintenance Manual* supplied with the module.

### Commissioning

Your system should be commissioned by an authorized TraceTek representative. The system map is a crucial part of a TraceTek locating system. The TTDM will give the point along the sensing cable at which liquid has been detected; the map is essential to show its physical location.

**Important:** Store hardware and documentation supplied with the TTDM in a secure place for later use (commissioning, connecting interfaces, operating).

# Raychem

**Belgium**  
 NV Raychem SA  
 Diestsesteenweg 692  
 3010 Kessel-Lo  
 Tel (32) 16/351-800  
 Fax (32) 16/351-797

**Korea**  
 Raychem Korea Limited  
 831-45 Yeuksam-Dong  
 Kangnam-Ku  
 Seoul 135  
 Tel (82) 2/557-7752  
 Fax (82) 2/558-5765

**United Kingdom**  
 Raychem Ltd.  
 Faraday Road  
 Dorcan, Wiltshire SN3 5HH  
 Tel (44) 1793/572-663  
 Fax (44) 1793/572-629

**United States**  
 Raychem Corporation  
 Commercial & Industrial  
 Infrastructure Division  
 300 Constitution Drive  
 Menlo Park, CA 94025-1164  
 Tel (800) 545-6258  
 Fax (800) 611-2323